

PXF40W-K V3.0

Small & Efficient Series & constant current LED driver

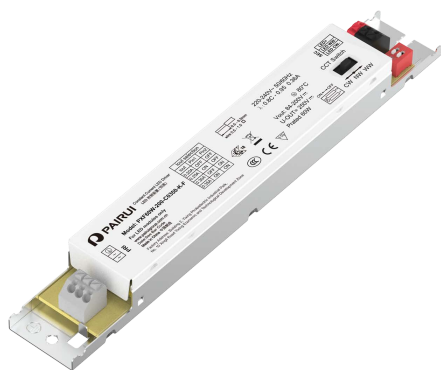

Product family features

- Drive Mode: Flicker-Free Constant Current
- Technology: 2-Stage PFC + Buck technology
- Input Voltage: 220 to 240VAC (maximum: 198-264 VAC)
- Output Frequency: 47-63Hz
- Output Power: 40Watt Max
- Output Voltage: 50Vdc to 133Vdc
- Output Current: 200mA to 350mA
- Efficiency: Up to 90%
- Warranty: 5years
- Constant Current, Current selection 4 steps, 50mA
- A rated lifetime of 50,000 hours @ Tc = 75 °C
- Non-isolated power
- Safety: GB 19510.1-2009; GB 19510.14-2009; EN 61347-1:2015, EN 61347-2-13:2014, EN 61347-2-13/A1: 2017; EU 2019/2020
- EMC: GB 17625.1-2012; GB/T 17743-2021; EN 55015; EN 61547; EN 61000-3-2; EN 61000-3-3; EN 61000-4-4; EN 61000-4-5
- Surge: line to line 1KV/2Ω 8/20 us, line to earth 2KV/12Ω 8/20us
- Metal shell. Meet the RoHS directive
- IP20, Compliant for Dry, Damp



Technical data

Electrical Parameter

Product Model	output Power (W)	Output Voltage (Vdc)	Output Constant Current (mA)	Current Accuracy (typ.)	Max Eff	Certification
PXF40W-133-C0350-K	40	50-133	200-350	±7.5%	90%	Erp,CE,ENEC,CCC,CB

Note: Maximum efficiency measured at 230VAC input, Current set at 350mA full load

Parts list

Part Number	PXF40W			
Output Current	200mA	250mA	300mA	350mA
Vf min	50V	50V	50V	50V
Vf max	133V	133V	133V	114V
Pomin	10.0W	12.5W	15.0W	17.5W
Pomax	26.6W	33.2W	39.9W	39.9W
Max U-OUT	250V			

Product datasheet

Technical data

Electrical Specifications

	Parameter	Min	Typ	Max	Notes / Conditions
Input	Input Voltage	198V		264V	220, 230, 240Vac Nominal Values
	Input Frequency	47Hz	50/60Hz	63Hz	50/60 Hz Nominal
	Standby Power			0.5W	No-load
	Leakage Current			450μA	Measured at 230Vac / 60Hz Input, Output Full Load
	THD			20%	Measured at 230Vac Input, Output Full Load
	Power Factor (PF)	0.68C		0.95	Measured at 220,230,240Vac Input
Parts list	Input AC Current			0.26A	Measured at 230Vac / 50Hz Input, Output Full Load
	Inrush Current (Peak)		23A / 240us		Pulse width Measured at 50% Ipeak & 240Vac / 50Hz Input Output Full Load
Output	Output Constant Current	-7.5%	Per Table	+7.5%	Per Tables on Page 1
	Current Selection		200mA		Pin1-OFF, Pin2-OFF
			250mA		Pin1-ON, Pin2-OFF
			300mA		Pin1-OFF, Pin2-ON
			350mA		Pin1-ON, Pin2-ON
	Output LF Current Ripple (<120 Hz)	-5%		+5%	20MHz BW, Measured at 230Vac / 50Hz Input, Output Full Load. Ripple Index is defined as [(Ymax-Ymin)/ Ymean]/2 * 100%. Y may be V or I.
	Fulfill TLA		PstLM<1, SVM<0.4		With specified LED load and full load
	Line Regulation	-3%		+3%	Measured at 220, 230, 240Vac / 60Hz Input, Output Full Load
	Load Regulation	-4%		+4%	Measured at 220, 230, 240Vac / 60Hz Input
	Start-up Time		200ms	500ms	Measured at 230Vac / 60Hz Input, Output Full Load
Output Overshoot	-2%		+10%	Measured at 220, 230, 240Vac Input, When power on or off	
Protection	Output Short Circuit (SCP)				No Damage. Auto recovery after short is removed
	Output Over Current (OCP)			+10% Io	Constant Current Limiting circuit
	Output Over Voltage (OVP)			120% Vo	No Damage. Auto recovery after short is removed
	Over Temp Protection(OTP)	95°C	100°C	110°C	lout Foldback at Tc>95°C, lout to off @ Tc~110°C
General	Cooling		Convection		
	MTBF		350,000 hours		Measured at 230Vac input, 100% Load and Ta=25°C(MIL-HDBK-217F)
	Life Time		50,000 hours		Measured at 230Vac input, 100% Load and TC=75°C
	Product Noise		< 24dBA		Class A, not to exceed at 1 meter at any dim level

	Parameter	Min	Max	Output Power	Notes / Conditions
Environmental	Operating Temperature (Ta)	-20°C	+60°C		@230Vac. This is a reference range. Tc controls temperature range
	Case Temperature (Tc)	-20°C	+80°C	40W	Measured at location specified on case
	Storage Temperature (Ts)	-40°C	+80°C		Non operating temperature range
	Operating Humidity	5% RH	85% RH		Relative Humidity. Non-condensing
	Vibration	5Hz	55Hz		2G, 10 minutes / 1 cycle, period 30 minutes, each along X, Y, Z axis

Product datasheet

Technical data

Electrical Specifications

	Take 350mA version for example	Channel #1 (LED- WW terminal)	Channel #2 (LED- CW terminal)
CCT Switch Concept	WW(warm white, eg-3000K)	350mA	Off
	NW(warm white, eg-4000K)	175mA	175mA
	CW(warm white, eg-6500K)	Off	350mA

	Category	Standards / Notes
Safety Compliance	CCC	GB 19510.1-2009; GB 19510.14-2009
	CE	EN 61347-1:2015, EN 61347-2-13:2014, EN 61347-2-13/A1:2017
	ErP 2.0	EU 2019/2020
	Enclosure / Ground - output	1.5KVac 3S
	Isolation Resistance	Input to PE/Housing: >10MΩ, 500Vdc @ 25°C, 70% RH
	FG	The metal case of the driver must be connected to earth ground (FG) in the end-use application
EMC Compliance	GB 17625.1-2012	Emc, limits, harmonic current emission values (equipment input current per phase < 16A)
	GB/T 17743-2021	Radio disturbance characteristics of electrical lighting and similar equipment limits and measurement methods
	EN 55015	Conducted emission Test & Radiated emission Test
	EN 61547	Electromagnetic Immunity Requirements Applies To Lighting Equipment
	EN 61000-3-2	Harmonic current limits
	EN 61000-3-3	Limits on voltage fluctuations and flickering (Rated current <16A)
	EN 61000-4-4	Electrical Fast Transient / Burst-EFT. No Flicker / Restart 2KV
	EN 61000-4-5	Surge Immunity Test: AC Power Line: line to line 1KV/2Ω 8/20us, line to earth 2KV/12Ω 8/20us

Note: The above test data are in the condition of 25°C ambient temperature, except for the marked temperature

Typical Applications

Constant Current Driver

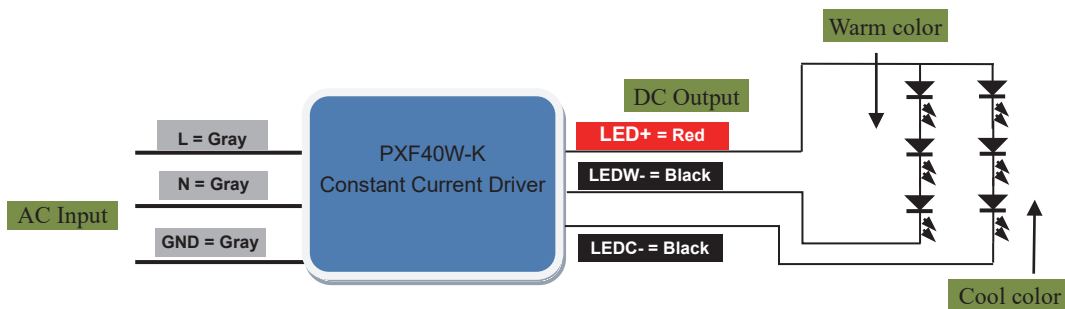

Product datasheet

Appearance information

Product Size

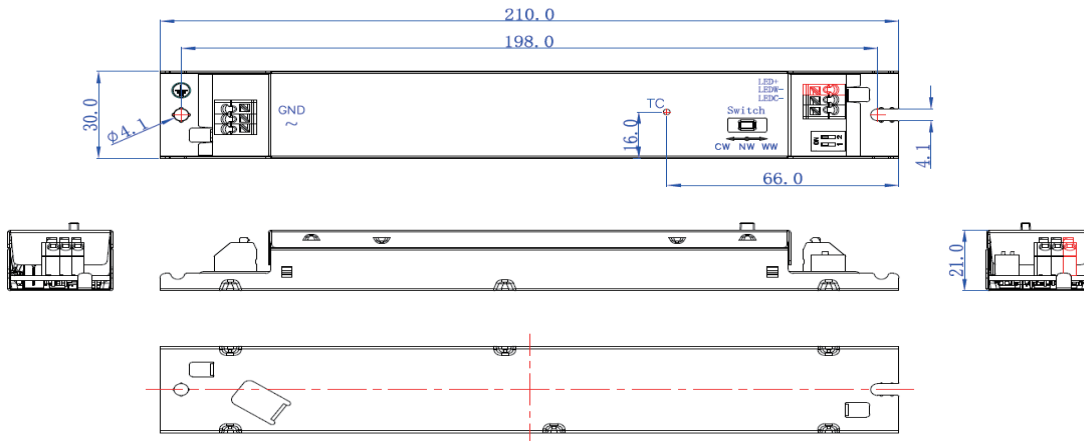

Note:

The independent LED drive conforms to the EMC standard. But it is not guaranteed to be qualified when the drive is mounted in the LED fixture
Please forgive us for any discrepancy due to the update of the specifications or the upgrade of the product. If you need the latest information, please contact our marketing department

Characteristic Curve

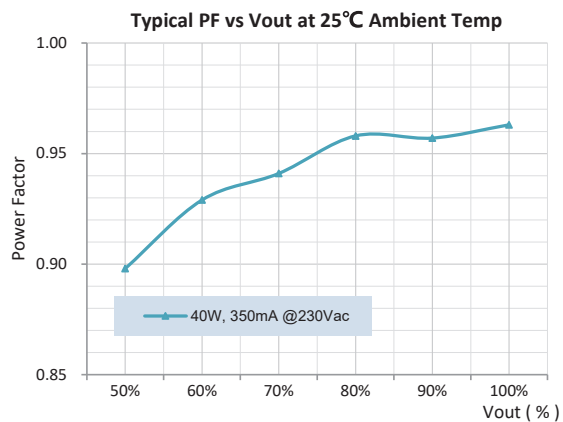
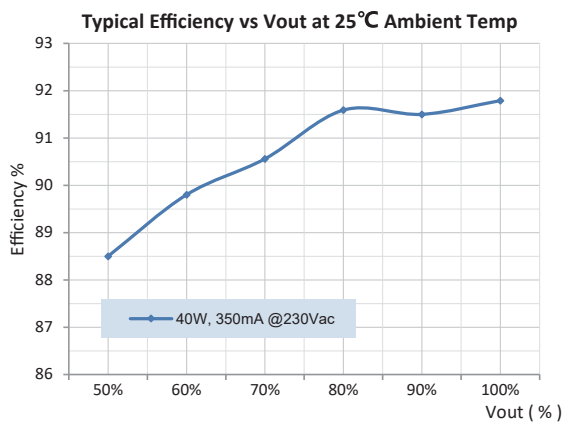

Product datasheet

Characteristic Curve

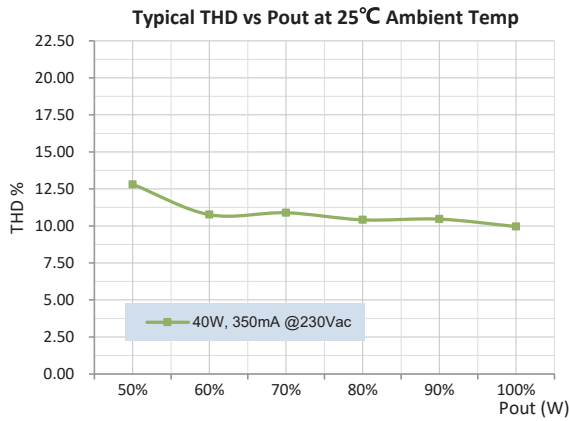

Lifetime Curve

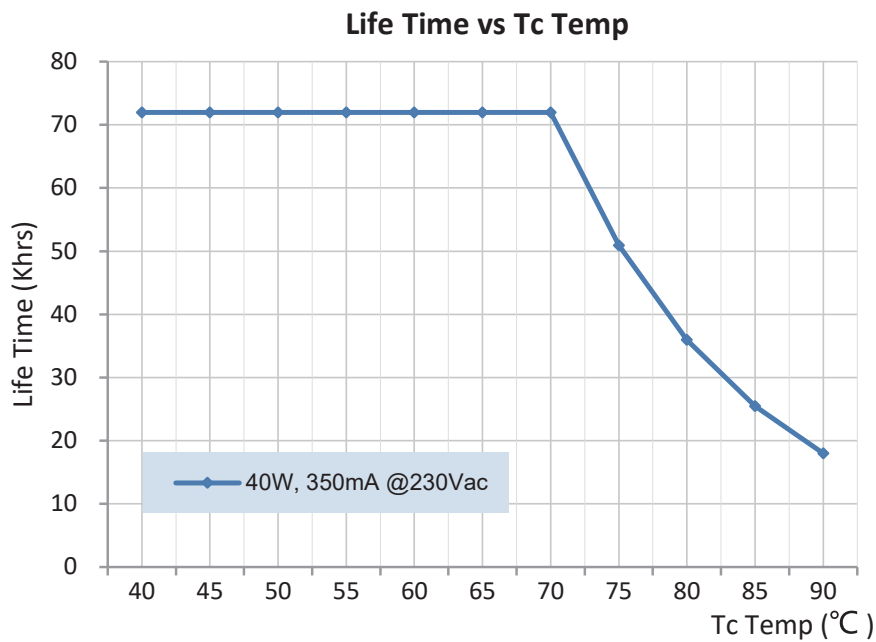

Installation

AC input wires cross section: 0.75~1.5mm²

DC output wires cross section: 0.75~1.5mm²

This product for indoor use only, it can be installed and fixed in the luminaires, connected with the wire. The length of output line should be less than 2m

Order ID

P/N: PXF40W-114-C0350-K (Pin1-ON, Pin2-ON.)

Description: 40W, 114Vdc voltage max, constant current 350mA, constant current mode