

P/N: FALCH1010T-270K3R7-□

Outline Dimensions(Unit:mm)

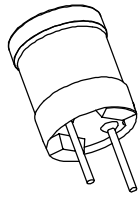
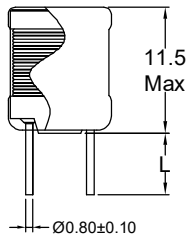

Pins Lead(L):

-5	5.00±1.0
-10	10.0±2.0
-15	15.0±3.0

FALCH1010T-270K3R7-5
 FALCH1010T-270K3R7-10
 FALCH1010T-270K3R7-15

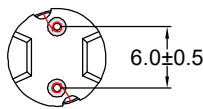
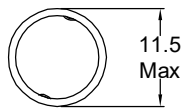

REMARK:

Products need thermal shrinkable sleeve.

Recommended Soldering Temperature Graph.

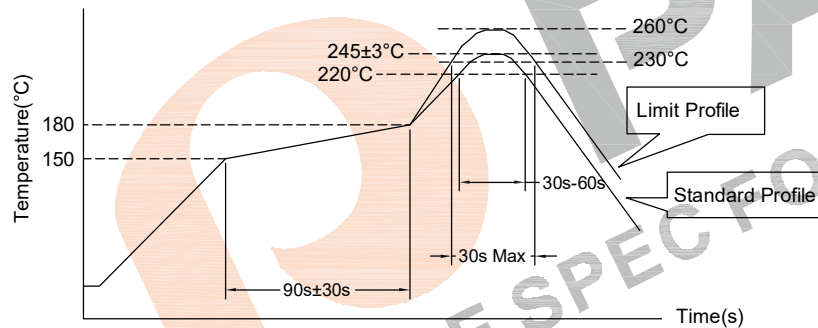

	Standard Profile	Standard Profile
Pre-heating	150~180°C,90s±30s	
Heating	above 220°C,30s-60s	above 240°C,30s Max
Peak temperature	245°C±3°C	260°C,10s
Cycle of reflow	2 times	2 times

Electronical Schematic

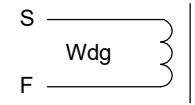

Electrical Characteristics(@25°C)

Inductance 1KHz,0.3V	DC Resistor	Temp. 40°C	Lldc: 1KHz,0.3V		
			10% drop	20% drop	30% drop
27uH±10%	38.0mΩ Max	3700mA	4000mA	4700mA	5200mA

***Operating Temperature: -40°C~+125°C.

(Temperature rise included)

***Storage Temperature : -40°C~+125°C.

***Storage Humidity:RH10%~70%.

Simulation test curve:

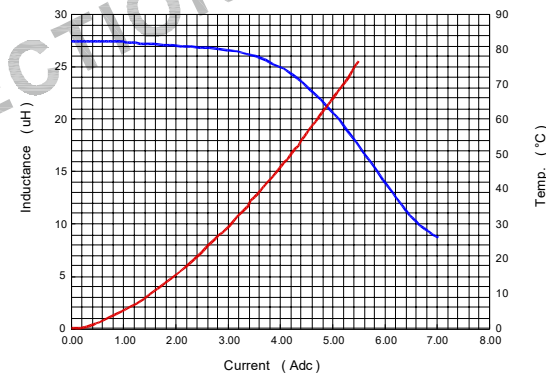

Material list

Part Name	SPEC	Supplier	UL Number
Core	DR2W10*10RF(B=4.7)-NiZn	LiCheng Electronic(ZhangZhou) Co.,Ltd	N/A
Wire	2UEW-F/155°C	ShangDong Saint Electric Co.,Ltd	E194410
Tube	Heat shrinkable casing/125°C	Changyuan Electronics (Shenzhen) Co Ltd	E180908

Tianchang Fuan Electronic Co Ltd
 www.fuantronics.net
 TEL: +86-550-7814888
 FAX:+86-550-7831133



Tolerances unless otherwise specified:
 (.X)±0.50 (.XX)±0.25
 Unit of measurement: mm

Drawn: *June*
 Checked: *Benson*
 Approved: *AmSon*

DRAWING TITLE
 DR2W10*10RF RADIAL FILTER CHOKE
 Material Number:

Customer Name:
 Document/Rev: 2211196/00
 Specification Sheet: 1 of 1
 Date of Recognition: Nov./08/2022

REV	DESCRIPTION	APPD	DATE