

FRAME CORE CHOKES FOR POWER LINES

FACCF23H SERIES

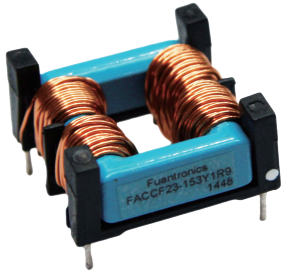

ELECTRICAL SPECIFICATION

- Rated voltage 250 VAC
- Rated current 0.7 A to 2.3 A
- Turns ratio: N1:N2=1:1±2%
- Hi-Pot: Pri-Sec: 1500VAC/5mA/2second
- Test Frequency Response: 10KHz 100mV
- Operating temperature range: -40°C to +105°C
- Inductance tolerance: +50/-30% at 25°C
- All parts meet RoHS compliance
- Weight: Approximately 18g

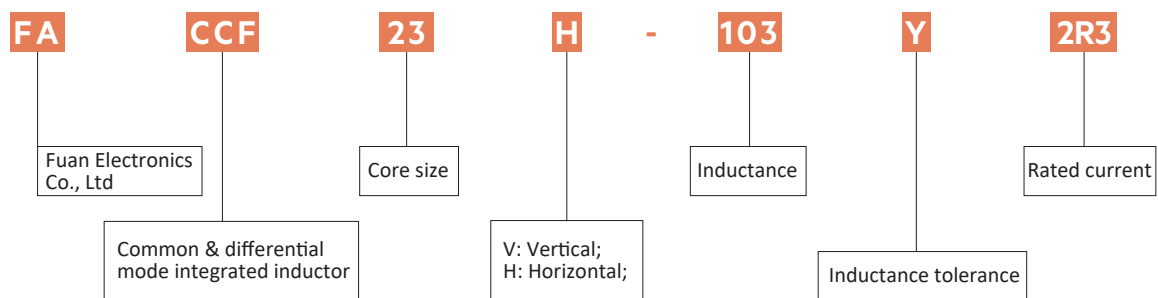

ELECTRICAL CHARACTERISTICS AT 25°C (H Series)

Part Number	Ind.(mH) 1KHz 0.25V Min	Lstray (uH) Typ	D.C.Resistance (ohms) Max	Rated Current (A)Typ
FACCF23H-103Y2R3	10	200	0.188	2.3
FACCF23H-153Y1R9	15	310	0.279	1.9
FACCF23H-273Y1R4	27	530	0.44	1.4
FACCF23H-393Y1R2	39	800	0.696	1.2
FACCF23H-473Y1R1	47	970	0.804	1.1
FACCF23H-683Y0R9	68	1440	1.1	0.9
FACCF23H-104Y0R7	100	2100	1.81	0.7

Product datasheet

ELECTRICAL INFORMATION

Dimension in mm

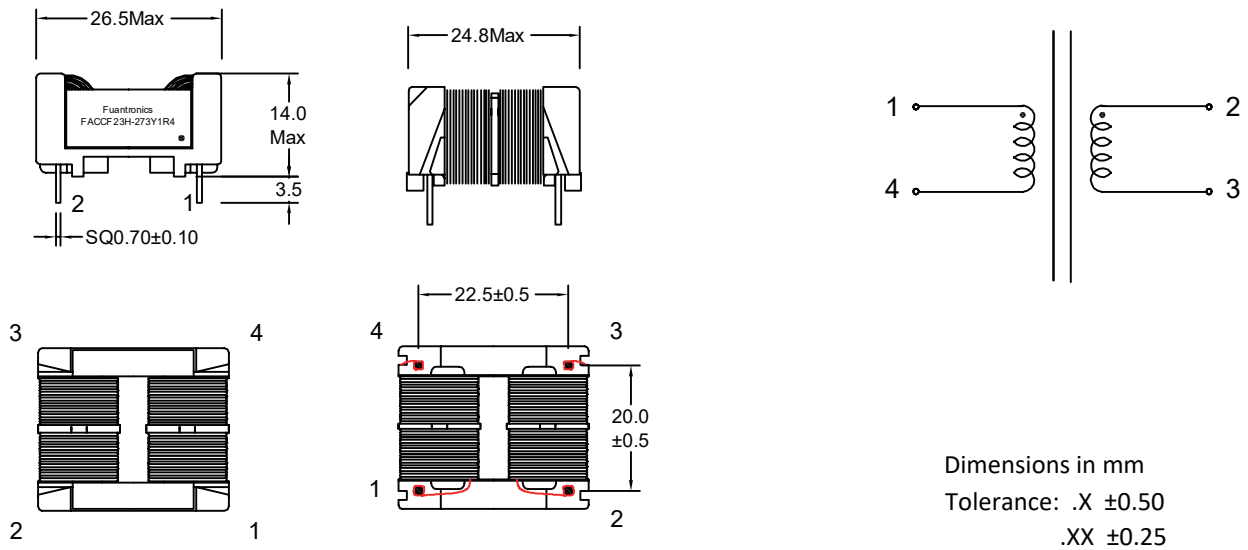

Dimensions in mm
Tolerance: .X ±0.50
.XX ±0.25