

**P3**      **T5\*3\*2**      **HP**  
**Material**    **Core Size**    **Coating**  
 材质            品名            涂装

HP:Parylene Coating of Ja;pgem-Free

## Ferrite core

### Dimensions: (UNIT:mm)

Dimensions(mm)			Wt(g/set)
Parylene Coating Dimensions(mm)			
ΦD1	ΦD2	H	0.14
5.0±0.3	3.0±0.3	2.0±0.2	
5.0±0.3	3.0±0.3	2.0±0.2	

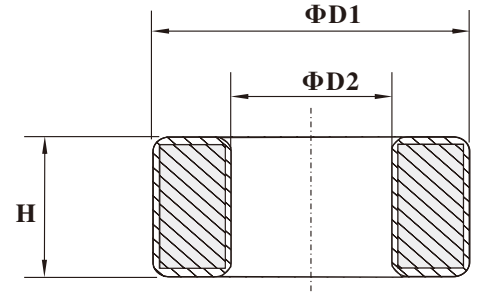
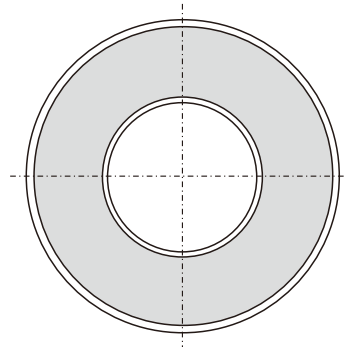

### Test Conditions

AL: F=10.0KHz    U=0.3V    N=10Ts

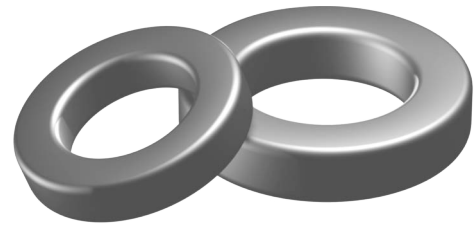

### Effective parameter

	Ve(mm <sup>3</sup> )	Ae(mm <sup>2</sup> )	Le(mm)
	24.6	2.0	12.3

### Coating

The core are coated with epoxy, flame retardant in accordance with "UL 94V-0" file number E228348.

The colour is green.

### Ring core data

GRADE	AL(nH)	μi	TYPE NUMBER
P3	470±25%	≈2300	T5/3/2/P3
H5K	1000±25%	≈5000	T5/3/2/H5K
H7K	1400±25%	≈7000	T5/3/2/H7K
H10K	2000±30%	≈10000	T5/3/2/H10K

### Note:

- 1: Document is the property of FUAN Inc & is not allowed to be duplicated without authorization
- 2: RoHS compliant.

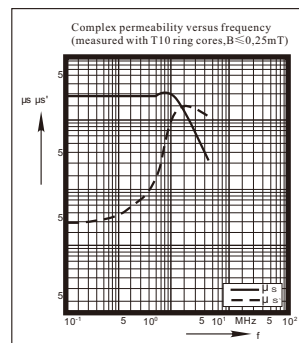

P3

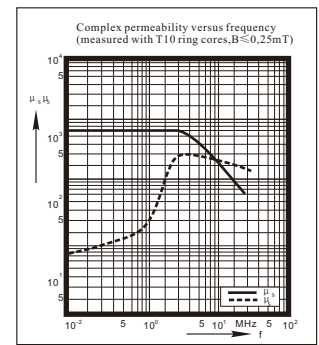

H5K

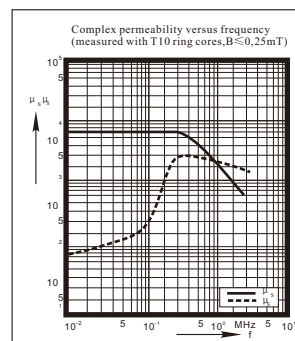

H7K

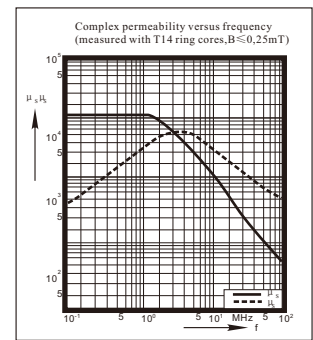

H10K