

**P3**      **T26\*14.5\*15**      **C/P**  
**Material**    **Core Size**    **Coating**  
 材质            品名            涂装

C=Epoxy. P=Parylene.

## Ferrite core

### Dimensions: (UNIT:mm)

Dimensions(mm)			
Epoxy Coating Dimensions(mm)			
ΦD1	ΦD2	H	Wt(g/set)
26.0±0.40	14.5±0.40	15.0±0.40	24.50
27.0max	13.5min	15.9max	

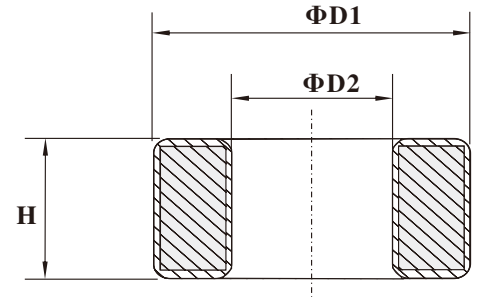
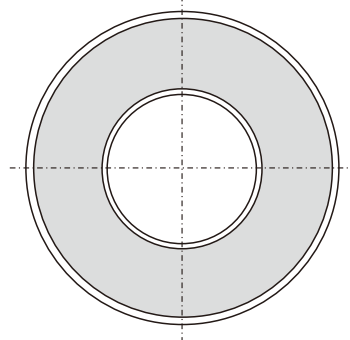

### Test Conditions

AL: F=10.0KHz U=0.3V N=10Ts

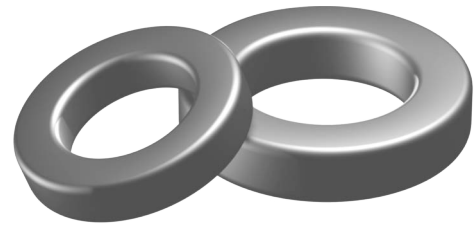

### Effective parameter

	Ve(mm <sup>3</sup> )	Ae(mm <sup>2</sup> )	Le(mm)
	5042	83.8	60.5

### Coating

The core are coated with epoxy, flame retardant in accordance with "UL 94V-0" file number E228348.

The colour is green.

### Ring core data

GRADE	AL(nH)	μi	TYPE NUMBER
P3	2800±25%	≈2300	T26/14.5/15/P3
H5K	8250±25%	≈5000	T26/14.5/15/H5K
H7K	11500±25%	≈7000	T26/14.5/15/H7K
H10K	17500±30%	≈10000	T26/14.5/15/H10K

### Note:

- 1: Document is the property of FUAN Inc & is not allowed to be duplicated without authorization
- 2: RoHS compliant.

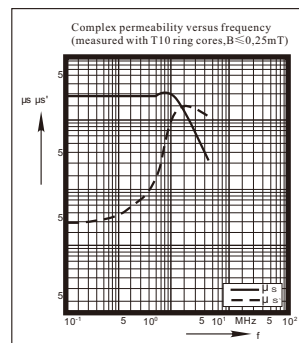

P3

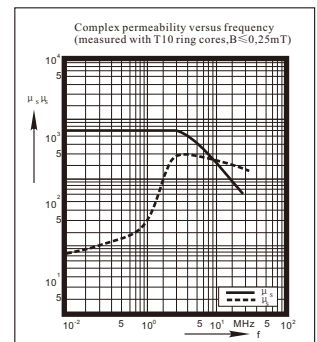

H5K

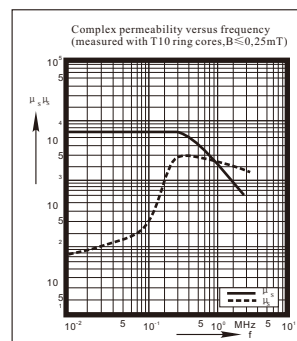

H7K

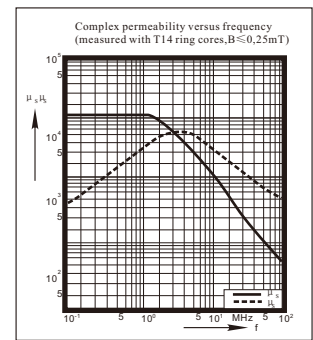

H10K