

P3 **T25*15*15** **C/P**
Material **Core Size** **Coating**
 材质 品名 涂层

C=Epoxy. P=Parylene.

Ferrite core

Dimensions: (UNIT:mm)

Dimensions(mm)			Wt(g/set)
Epoxy Coating Dimensions(mm)			
ΦD1	ΦD2	H	23.30
25.0±0.40	15.0±0.40	15.0±0.40	
26.0max	14.0min	15.9max	

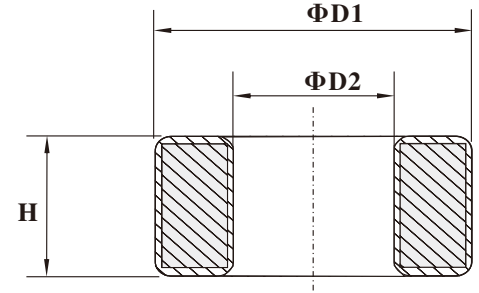
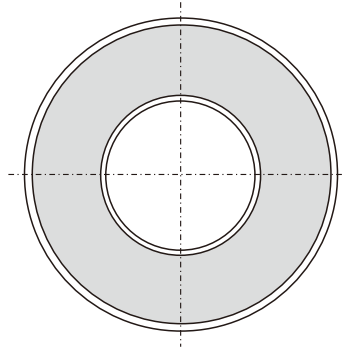

Test Conditions

AL: F=10.0KHz U=0.3V N=10Ts

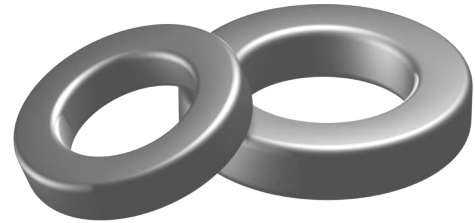

Effective parameter

	Ve(mm ³)	Ae(mm ²)	Le(mm)
	4420	73.4	60.2

Coating

The core are coated with epoxy, flame retardant in accordance with "UL 94V-0" file number E228348. The colour is green.

Ring core data

GRADE	AL(nH)	μi	TYPE NUMBER
P3	3700±25%	≈2300	T25/15/15/P3
H5K	7650±25%	≈5000	T25/15/15/H5K
H7K	10700±25%	≈7000	T25/15/15/H7K
H10K	15300±30%	≈10000	T25/15/15/H10K

Note:

- 1: Document is the property of FUAN Inc & is not allowed to be duplicated without authorization
- 2: RoHS compliant.

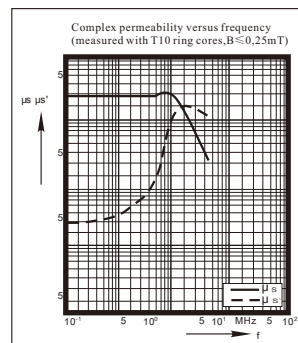

P3

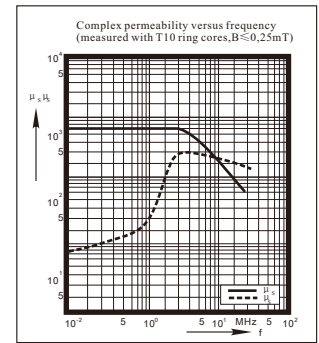

H5K

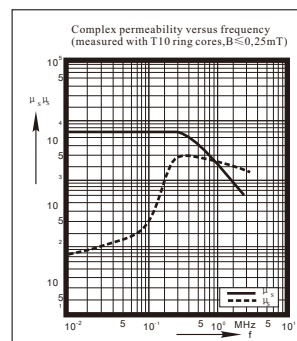

H7K

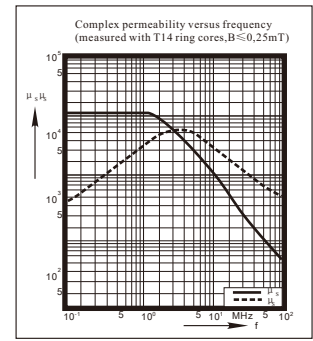

H10K