



PAIRUI

Http: fuantronics.com

P3 **T20*12*8** **C/P**
Material **Core Size** **Coating**
 材质 品名 涂装

C=Epoxy. P=Parylene.

Ferrite core

Dimensions: (UNIT:mm)

Dimensions(mm)			
Epoxy Coating Dimensions(mm)			
ΦD1	ΦD2	H	Wt(g/set)
20.0±0.40	12.0±0.40	8.0±0.30	7.60
21.00max	11.00min	8.90max	

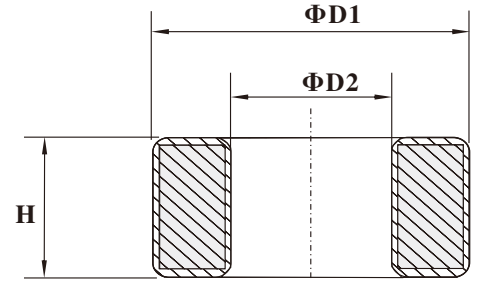
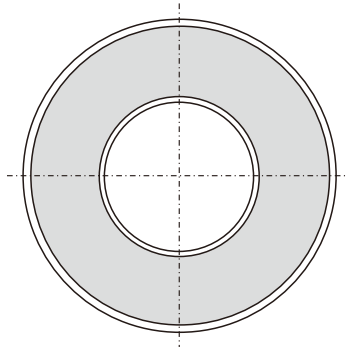

Test Conditions

AL: F=10.0KHz U=0.3V N=10Ts

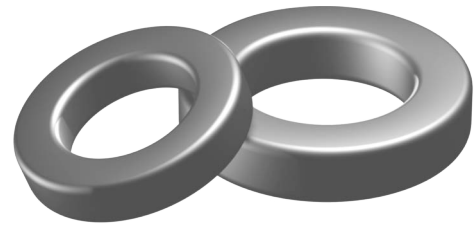

Effective parameter

	Ve(mm3)	Ae(mm2)	Le(mm)
	1505	31.3	48.1

Coating

The core are coated with epoxy, flame retardant in accordance with "UL 94V-0" file number E228348. The colour is green.

Ring core data

GRADE	AL(nH)	μi	TYPE NUMBER
P3	2000±25%	≈2300	T20/12/8/P3
H5K	4100±25%	≈5000	T20/12/8/H5K
H7K	5700±25%	≈7000	T20/12/8/H7K
H10K	8200±30%	≈10000	T20/12/8/H10K

Note:

- 1: Document is the property of FUAN Inc & is not allowed to be duplicated without authorization
- 2: RoHS compliant.

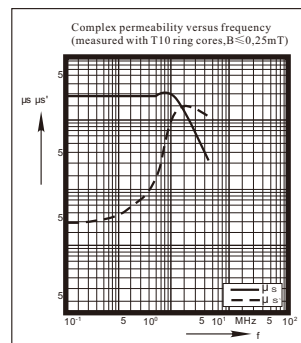

P3

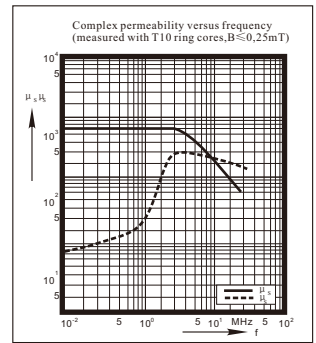

H5K

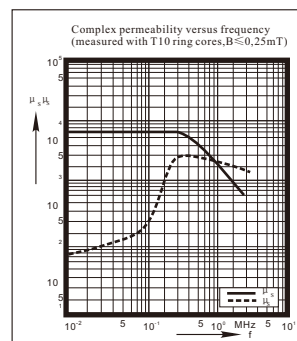

H7K

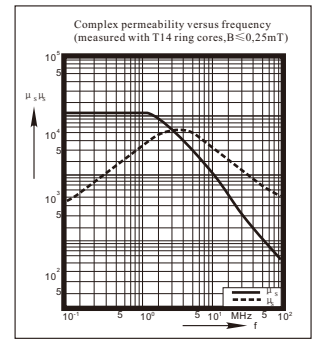

H10K