

**P3**      **T12\*6\*4**      **C/P**  
**Material**      **Core Size**      **Coating**  
 材质      品名      涂装

C=Epoxy. P=Parylene.

## Ferrite core

### Dimensions: (UNIT:mm)

Dimensions(mm)			
Epoxy Coating Dimensions(mm)			
ΦD1	ΦD2	H	Wt(g/set)
12.0±0.40	6.00±0.30	4.00±0.20	1.51
13.0max	5.1 min	4.90 max	

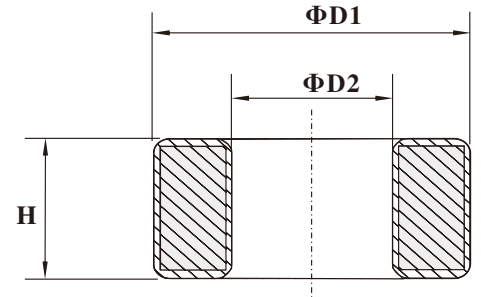
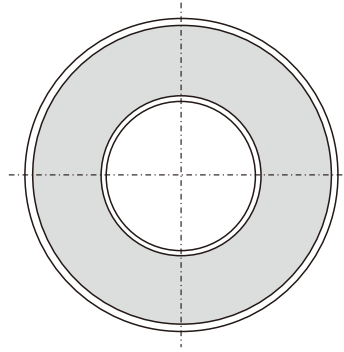

### Test Conditions

AL: F=10.0KHz U=0.3V N=10Ts

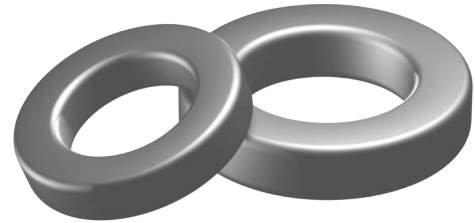

### Effective parameter

	Ve(mm <sup>3</sup> )	Ae(mm <sup>2</sup> )	Le(mm)
	326	12.0	27.2

### Coating

The core are coated with epoxy, flame retardant in accordance with "UL 94V-0" file number E228348.

The colour is green.

### Ring core data

GRADE	AL(nH)	μi	TYPE NUMBER
P3	1300±25%	≈2300	T12/6/4/P3
H5K	2800±25%	≈5000	T12/6/4/H5K
H7K	3900±25%	≈7000	T12/6/4/H7K
H10K	5600±30%	≈10000	T12/6/4/H10K

### Note:

- 1: Document is the property of FUAN Inc & is not allowed to be duplicated without authorization
- 2: RoHS compliant.

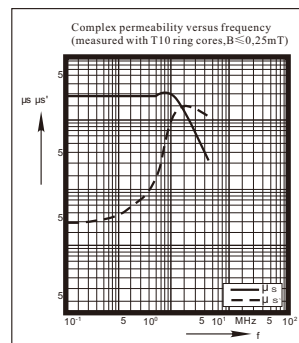

P3

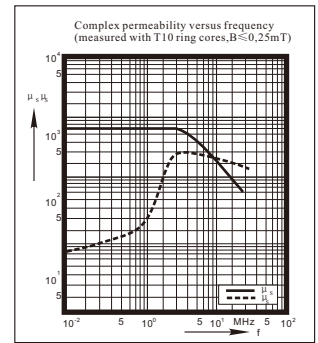

H5K

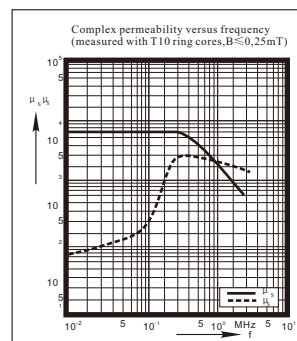

H7K

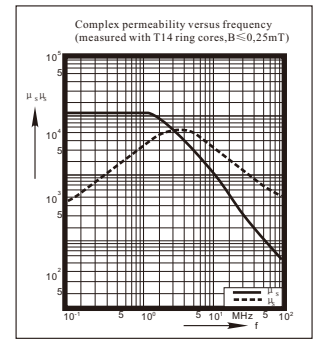

H10K