

COIL FORMER
General data POT26/16 coil former

PARAMETER	SPECIFICATION
Coil former material	polyamid (PA66), glass reinforced, flame retardant in accordance with "UL 94HB"; UL file number E41938
Pin material	
Maximum operating temperature	130°C, "IEC 60085", class B
Resistance to soldering heat	"IEC 60068-2-20", Part 2, Test Tb, method 1B, 350 °C, 3.5 s
Soldeerability	"IEC 60068-2-20", Part 2, Test Ta, method 1

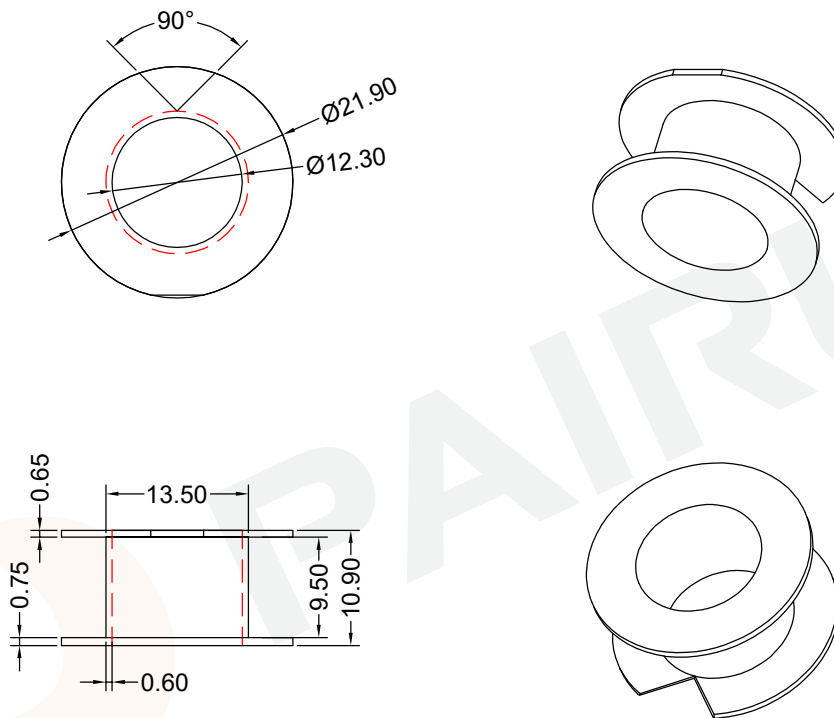

Winding data and area product for POT26/16 coil former

NUMBER OF SECTIONS	WINDING AREA (mm ²)	MINIMUM WINDING WIDTH (mm)	AVERAGE LENGTH OF TURN (mm)	AREA PRODUCT Ae x Aw (mm ⁴)	TYPE NUMBER
1	40	9.50	56	3760	POT-2601-1-1S-0P

Tolerances unless otherwise specified:
 $0 < L \leq 4 \pm 0.10$ $4 < L \leq 16 \pm 0.20$
 $16 < L \leq 45 \pm 0.30$ $45 \leq L \pm 0.40$
 Pin Dim: ± 0.05 Thickness: ± 0.20 Pin Pitch: ± 0.20

Dimensions:
(mm)

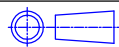

REMARK

Mould No.: POT2601-1

Bobbin material: PA66

Code No.: FAY01091

Available for Fuan core: POT26/16



Fuan Electronics

TEL :0086-514-87693589
 EML :sales@fuantronics.net
 WEB:www.fuantronics.net

Make: P.Xiao

Material Number: A4C260110200

Checked: Beson. zhan

Document/Rev: 00

Approved: Anson. zhan

Date of Recognition: Oct./17/2019