

P/N: FALCHA0617-150K

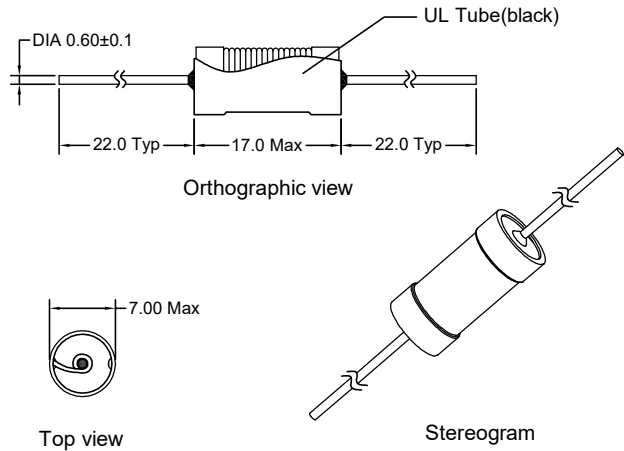

Outline Dimensions(Unit:mm)



REMARK:
1. Products need thermal shrinkable sleeve.

Electrical Schematic

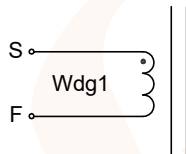

Electrical Characteristics(@25°C)

Inductance 1KHz,0.25V S-F	DC Resistor S-F	Rated Current
15.0uH±10%	0.040Ω Max	1280mA

***Operating Temperature: -40°C~+125°C.
(Temperature rise included)
***Storage Temperature : -40°C~+125°C.
***Storage Humidity:RH10%~70%.

Material list

Part Name	SPEC	Material Type	Supplier	UL Number
Core	DRWW6*13 (B=2.5)	NiZn	Zhongshan Jiaxin Electronic Co Ltd	N/A
Copper Wire	2UEW-F	155°C	Elektrisola Hangzhou Co Ltd	E258243
Tube	RSFR-H/600V	125°C	ShenZhen Woer Heat-shrinkable Material Co Ltd	E203950

Recommended Soldering Temperature Graph.

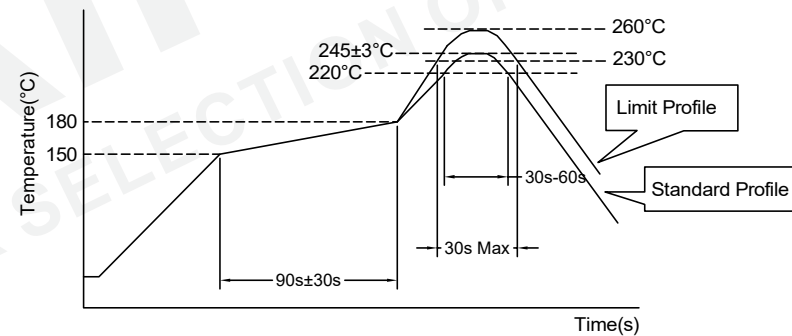

	Standard Profile	Standard Profile
Pre-heating	150~180°C,90s±30s	
Heating	above 220°C,30s-60s	above 240°C,30s Max
Peak temperature	245°C±3°C	260°C,10s
Cycle of reflow	2 times	

REV	DESCRIPTION	APPD	DATE	Tianchang Fuan Electronic Co Ltd www.fuantronics.net TEL: +86-550-7814888 FAX: +86-550-7831133	 Tolerances unless otherwise specified: (.X)±0.50 (.XX)±0.25 Unit of measurement: mm	Make: Qiumei.Liu Checked: Beson. zhan Approved: Anson. zhan	DRAWING TITLE DRWW6*13 RADIAL FILTER CHOKE Material Number: A330617XS070	Customer Name: Document/Rev: 00 Specification Sheet: 1 of 1 Date of Recognition: Mar./23/2020
-----	-------------	------	------	---	---	---	---	--