

P/N: FALCHA0410-102K

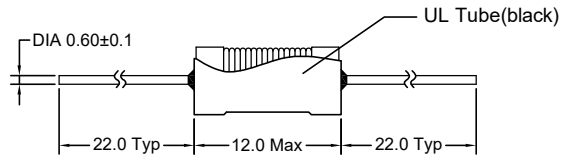

Outline Dimensions(Unit:mm)



Orthographic view

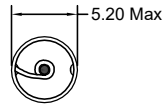

Top view

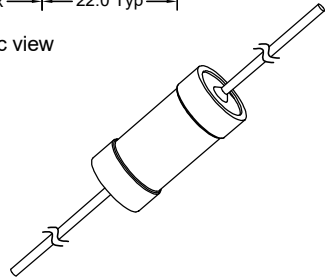

Stereogram

REMARK:

1. Products need thermal shrinkable sleeve.

Electrical Schematic

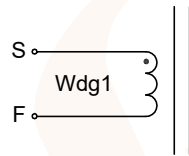

Electrical Characteristics(@25°C)

Inductance 1KHz,0.25V S-F	DC Resistor S-F	Rated Current
1.00mH±10%	7.90Ω Max	95mA

- ***Operating Temperature: -40°C~+125°C.
(Temperature rise included)
- ***Storage Temperature : -40°C~+125°C.
- ***Storage Humidity:RH10%~70%.

Material list

Part Name	SPEC	Material Type	Supplier	UL Number
Core	DRWW 4*10 (B=1.5)	NiZn	Zhongshan Jiaxin Electronic Co Ltd	N/A
Copper Wire	2UEW-F	155°C	Elektrisola Hangzhou Co Ltd	E258243
Tube	RSFR-H/600V	125°C	ShenZhen Woer Heat-shrinkable Material Co Ltd	E203950

Recommended Soldering Temperature Graph.

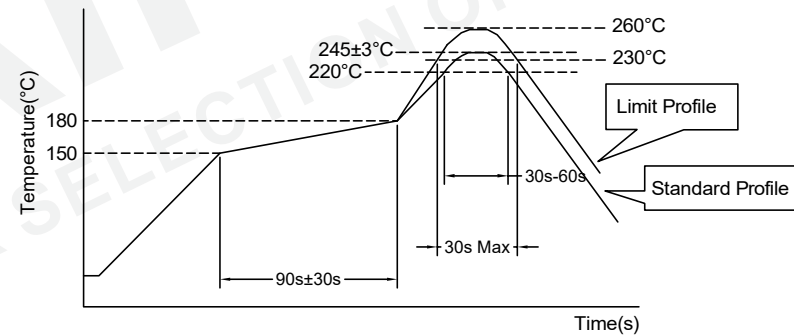

	Standard Profile	Standard Profile
Pre-heating	150~180°C,90s±30s	
Heating	above 220°C,30s-60s	above 240°C,30s Max
Peak temperature	245°C±3°C	260°C,10s
Cycle of reflow	2 times	

REV	DESCRIPTION	APPD	DATE	Tianchang Fuan Electronic Co Ltd www.fuantronics.net TEL: +86-550-7814888 FAX: +86-550-7831133	 Tolerances unless otherwise specified: (X)±0.50 (XX)±0.25 Unit of measurement: mm	Make: Qiumei.Liu Checked: Beson. zhan Approved: Anson. zhan	DRAWING TITLE DRWW4*10 RADIAL FILTER CHOKE Material Number: A330410XS740	Customer Name:
								Document/Rev: 00
								Specification Sheet: 1 of 1
								Date of Recognition: Mar./23/2020

Cautions and Warnings

提醒及警告



富安产品范围:

1.FUAN components are manufactured and promoted for applying in general electronics devices such as audio-video equipment, home electric appliance, office automation equipment, communication equipment, power module, LED lighting, measurement hardware, machine accessory, etc.

(本公司的产品使用于影音,家电,办公自动化,通讯,电源模块,LED照明,测量设备,机械工具等一般电子设备中.)

2.If FUAN product will be applied in area like automotive product, medical equipment, military and aerospace except general electronic device, please keep FUAN sales informed in advance. FUAN shall not be held liable for any malfunction or breakdown caused by using product in the condition which is inconsistent with that recommended by FUAN.

(当本公司产品使用在一般电子设备以外的场合,如:车站,医疗设备,军用,航空航天等,请务必联系本公司营业部门,如超出本公司产品使用条件而引起的机器故障时,本公司概不负责.)

3.If there is problem occurring when using product or information on FUAN's catalogue, which may affect industrial property or any other rights of FUAN Group (or a third party), FUAN Group shall not be held liable in such situation, nor grant any license to the offending party.

(在使用本公司的目录上的产品或信息时,如发生涉及到本公司或第三者的产业财产权(工业所有权)以及其他权利的相关问题,本公司恕不负责,亦不授权给侵害方.)

4.Some parts of this publication contain statements about the suitability of our products for certain areas of application. These statements are based on our knowledge of typical requirements that are often placed on our products in the areas of application concerned. We nevertheless expressly point out that such statements cannot be regarded as binding statements about the suitability of our products for a particular customer application.

(在此处指明的一些产品包含有关我们的产品在某些应用领域的适用性陈述.这些陈述是基于我们有关应用领域中经常放在的产品上的典型要求了解.然而,我们明确指出,这些声明不能被视为对某些特殊的客户运用适合的声明.)

5.Generally, FUAN might not be familiar with either customer's specific application or actual requests as customer does. As a result, customer shall be responsible for checking and confirming whether FUAN product with the performance described in the product specification is suitable for using in customer's particular application or not.

(通常情况下,富安不熟悉特定客户的应用,也不熟悉客户本身需求,由于这些原因,客户始终有责任检查并确定具有产品规格中描述的属性的富安产品是否适合在特定客户的应用.)

6.We also have to point out that in individual cases, any trouble or failure of electronic components happens during their long span cannot not be completely cleared even if someone operates according to instruction with existing technology.

(在个案中,我们也要指出,在现有技术中,即使按照规定进行操作,电子元件在其通常使用寿命结束之前发生故障也不能完全排除的.)

7.Please pay attention to the storage conditions that temperature: below 35°C and humidity: 35-65% RH. If product is preserved for more than 1 year, the solderability of their terminals may be deteriorated.

(产品在规定的温度和湿度条件下保存:温度: 35°C以下,湿度: 35-65% RH, 如果保存期超过1年,端子的可焊性可能会变差.)

8.The aforementioned items do not apply to individual agreements and the foregoing customer-specific products.

(上述内容不适用于个人协议和客户上述提到的特定产品.)

General instruction for parts usage:

零件使用一般说明:

1. Please pay more attention to the installation position of the non-magnetic shield type coil when you design the printed circuit board to prevent malfunction caused by magnetic interference.

(在设计PCB时,请考虑非磁屏蔽元器件的安装位置,避免磁干扰引起的故障.)

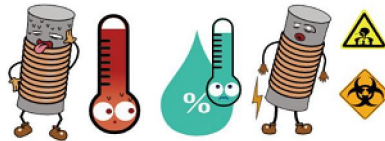
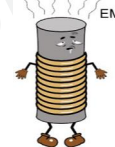

2. Product should not be exposed to environment with high temperature, high humidity, dust, corrosive gas and etc.

(请不要将产品保存在高温/高湿/有灰尘,腐蚀性气体等不适合环境中.)

3.The soldering conditions should also be observed. Temperature mentioned refers to the temperature of wave soldering for PIN or terminals but not the temperature of product itself.

(应留意焊锡条件,说明中如有提及到焊锡温度,是指PIN或端子侵入波峰焊的温度,而不是指产品本体.)



				Tianchang Fuan Electronic Co Ltd www.fuantronics.net TEL: +86-550-7814888 FAX: +86-550-7831133	 Tolerances unless otherwise specified: (X)±0.50 (XX)±0.25 Unit of measurement: mm	Make: Qiumei.Liu Checked: Beson. zhan Approved: Anson. zhan	DRAWING TITLE CAUTIONS AND WARNINGS Material Number:	Customer Name: Document/Rev: Specification Sheet: Date of Recognition:
REV	DESCRIPTION	APPD	DATE					

Cautions and Warnings

提醒及警告



4. Please take the thermal design into consideration when choosing appropriate product, because the coil generates heat when electric current is applied.

(工作时电流通过绕组会产生一定的热量,在选用试请做散热设计之考量.)

5. Please don't use products in a place with dewing. Please be careful when products is applied in a sealed condition since dewing would happen due to temperature change.

(请避免在结露的环境下使用,在密闭环境中,由于温度的变化会导致结露,使用时请注意.)

6. Please always handle products carefully to prevent any damage caused by dropping down or inappropriate removing.

(请小心轻拿轻放,避免由于产品的跌落或取出不当而导致的损坏.)

7. Don't touch electrodes directly with bare hands since oil secretions may do harm to solderability.

(手上有油脂可能导致可焊性下降,请避免手直接接触端子.)

8. Don't bend the terminals with excessive stress in case of any wire fracture.

(端子过度弯曲会导致断线,请不要过度弯曲端子.)

9. Please ensure that all terminals and case lugs are completely fixed onto PCB by soldering, and avoid placing coils near the edge of the PCB.

(请确保所有端子和胶壳足完全焊接到印刷电路板上,尽量避免产品放在印刷电路板边缘.)

10. Don't rinse coils by yourself and please contact FUAN if necessary.

(不要清洗产品,如需要清洗时请联系我司.)



11. Since our SMD coils are designed for automatic mounting, please be careful when soldering manually. Please don't touch any exposed winding part and coil should not be used guiding by electrode in automatic mounting.

(由于表面贴装件都是以自动安装为基准设计,手动焊锡时请注意.产品自动安装,请避免接触卷线露出的部分.另外,不能将端子作为导向使用.)

12. Our specification specifies the quality of the component as a single unit. Please ensure the component is thoroughly evaluated in your application circuit.

(本公司的规格书中只规定了产品的品质,在贵司使用中,请务必确认安装在贵公司产品的状态.)



13. When using our high voltage inverter transformers, please place it 2mm away from other electric conductors.

(对于产品高压的逆变变压器,在使用设计时要注意其他导体要离逆变器2mm以上.)

				Tianchang Fuan Electronic Co Ltd www.fuantronics.net TEL: +86-550-7814888 FAX: +86-550-7831133	 Tolerances unless otherwise specified: (X)±0.50 (XX)±0.25 Unit of measurement: mm	Make: Qiumei.Liu Checked: Beson. zhan Approved: Anson. zhan	DRAWING TITLE CAUTIONS AND WARNINGS Material Number:	Customer Name: Document/Rev: Specification Sheet: Date of Recognition:
REV	DESCRIPTION	APPD	DATE					

Notes for Electrical Characteristics Test

电气特性试验注意事项



Note 1. The general testing condition is Temperature: 25 +/- 5°C (Room temperature) and humidity: 35-65% RH, which is applied to all products except specific product.

(注意 1. 除非特别指定,所有产品测试条件为:温度:25±5°C(室温),湿度:35-65%RH.)

Note 2. For DIP type products, when the pin length is more than 5mm, the test position should be at 2-5mm away from the bottom of the product; For SMT type products, it is suggested to ensure better contact between the products and the tooling, shown as the right picture:

(注意 2. DIP产品脚长超过5mm时,测试位置应选取在产品底部2-5mm处,对SMT产品,产品的测试端子与夹具接触良好.如右图:)

1. Inductance Test(电感测试)

There could be measurement deviations with different instruments due to different test principles / internal resistance. Open and Short compensation should be performed before testing. Select the measurement fixture or testing wire that goes with the original instrument.

(不同仪器会因测试内阻及方法的不同而导致测试偏差,测量前需要进行归零补偿,测量时请选取仪器自带的治具及测试线.)

2. Leakage Inductance Test(漏感测试)

There could be measurement deviations with different instruments due to different test principles / internal resistance. Open and Short compensation should be performed before testing. Select the measurement fixture or testing wire that goes with the original instrument.

(不同仪器会因测试内阻及方法的不同而导致测试偏差,测量前需要进行归零补偿,测量时请选取仪器自带的治具及测试线.)

3. DCR Test(直流电阻测试)

Shorten the testing wire as much as possible to ensure better contact between the products and the tooling; there would be deviations for the DCR if the testing tooling contact surface is worn out or if the testing method is not correct, especially for low DCR products.

(尽量减短测试线的长度,保证产品与治具良好接触,当测试夹具接触面磨损或测量方法不正确时,会导致DCR值的偏差,特别是当DCR值较小时.)

4. Rated Current, Saturation Current, Temperature Rise Current(额定电流,饱和电流,温升电流)

The saturation current is decided according to the initial inductance drop amount; the rated current is generally taken by the smaller value between the saturation current and temperature rise current.

(饱和电流依初始电感下降变化量来选取;额定电流一般选取饱和电流和温升电流两者之间取较小值.)

5. Q Factor / SRF / Z Test(品质因数/SRF/阻抗测试)

Shorten the pin length as much as possible to ensure better contact between the products and the tooling ;there can be deviation if the testing tooling contact surface is worn out or if the testing method is not correct.

(尽量减短引线的长度,保证产品与治具良好的接触,当测试夹具接触面磨损或测量方法不正确时,会导致测试值的偏差.)

6. Turns Ratio and Phase Test(圈比及相位测试)

There would be deviations for turn counts ratio when there is magnetic leakage or air gap in the core center, please pay attention to the differences during testing. If the air gap is too large, then use the planar cores for confirmation; be careful to choose the foot position when testing the polarity.

(漏磁及产品耦合不良等原因会导致圈比测试偏差,请在测试中注意区分;当产品的气息过大时,请使用平面磁芯确认,相位测试注意脚位选取.)

7. Hi-Pot Test(高压测试)

Choose AC or DC accordingly during Hi-pot testing since they are different. If the humidity is too high or there is pollution on the surface, the Hi-pot test might fail. Please avoid testing in high humidity condition and keep the tooling and products clean. The Hi-pot test is destructive test and repeat testing should be avoided.

(AC与DC的耐压不同,请在测试时选择相应的设置,湿度过高及表面受污染则可能会导致耐压不良,请避免在高湿下测试并保持治具及测试产品干净.耐压测试为破坏性测试,请避免重复测试.)

8. IWT Test(层间短路测试)

Carefully choose the voltage and standard sample for the testing, IWT test is destructive testing and repeat testing should be avoided.

(注意电压和标准样品的选取,测试为破坏性测试,避免重复测试.)

Please read cautions and warnings, important notes at the end of this document. If you have any question, please contact FUAN.

(请阅读本文件末尾的注意事项和警告、重要注意事项.)

(如果您有任何问题,请联系富安.)



Optimal Testing position
最佳测试位置

Wrong testing position
测试位置错误

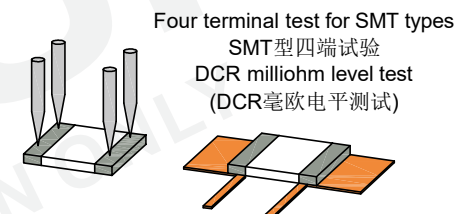

Four terminal test for SMT types
SMT型四端试验
DCR milliohm level test
(DCR毫欧电平测试)

Two sides test for SMT types
SMT型双面试验

				Tianchang Fuan Electronic Co Ltd www.fuantronics.net TEL: +86-550-7814888 FAX: +86-550-7831133		Make: Qiumei.Liu	DRAWING TITLE NOTES FOR ELECTRICAL CHARACTERISTICS TEST	Customer Name:
				Tolerances unless otherwise specified: (.X)±0.50 (.XX)±0.25 Unit of measurement: mm	Checked: Beson. zhan	Document/Rev:		
REV	DESCRIPTION	APPD	DATE		Approved: Anson. zhan	Material Number:		Specification Sheet: